



# Box Sofa

2-Seater Sofa



Maker skills



Woodworker

Do It Locally  
Make Pack



## A - Overview of sofa

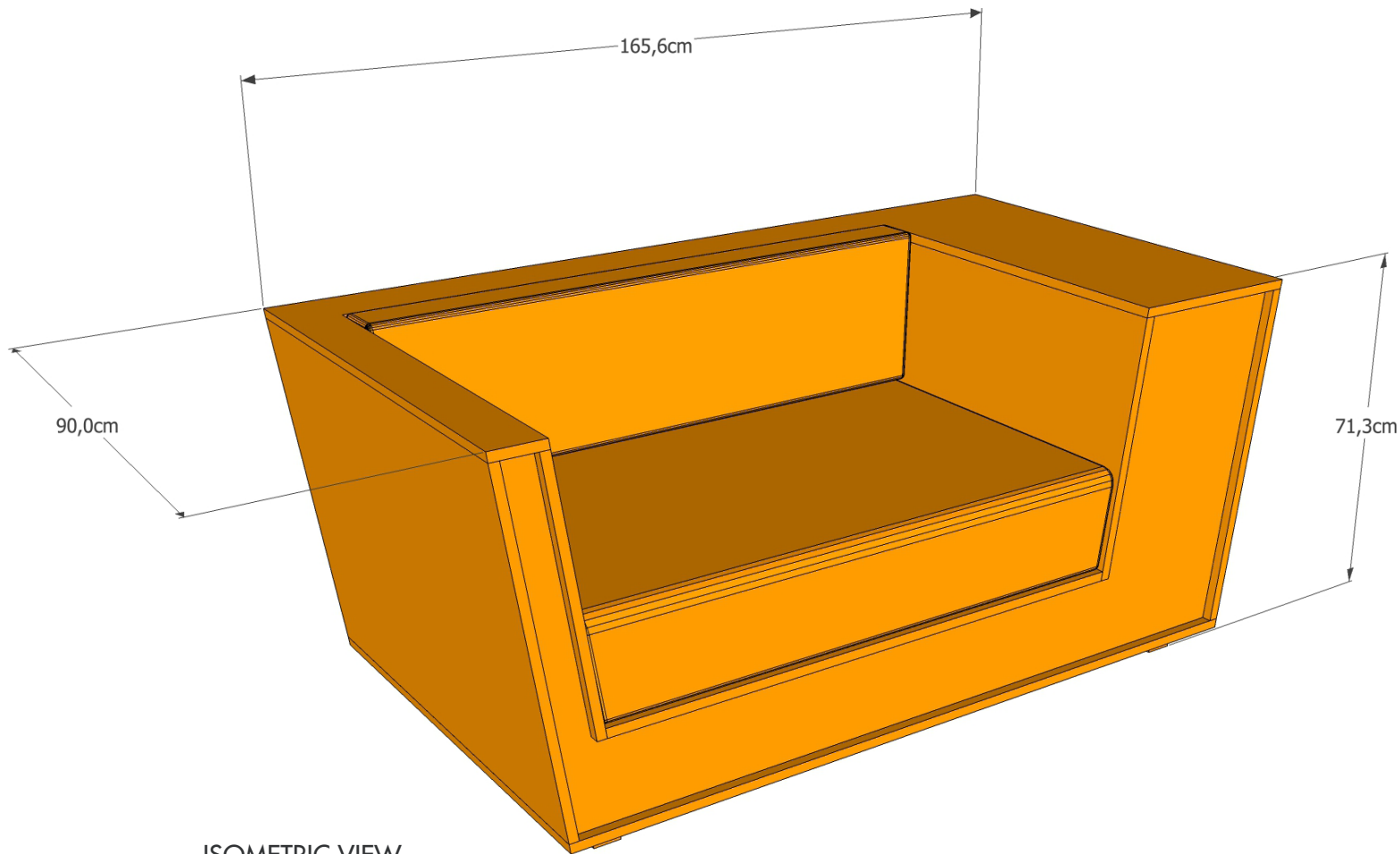

The Box Sofa is a stylish 2-seater sofa with a large table and arm rest in an iconic box shaped design. Combining certified Spruce ply and colourful hemp upholstery this sofa is unique in style and look.



## B - Construction

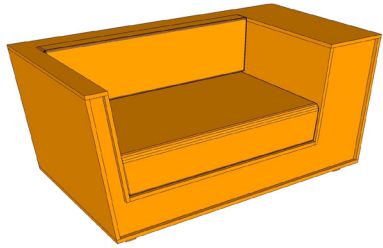

The foam cushions are upholstered with 100% hemp woven fabric.

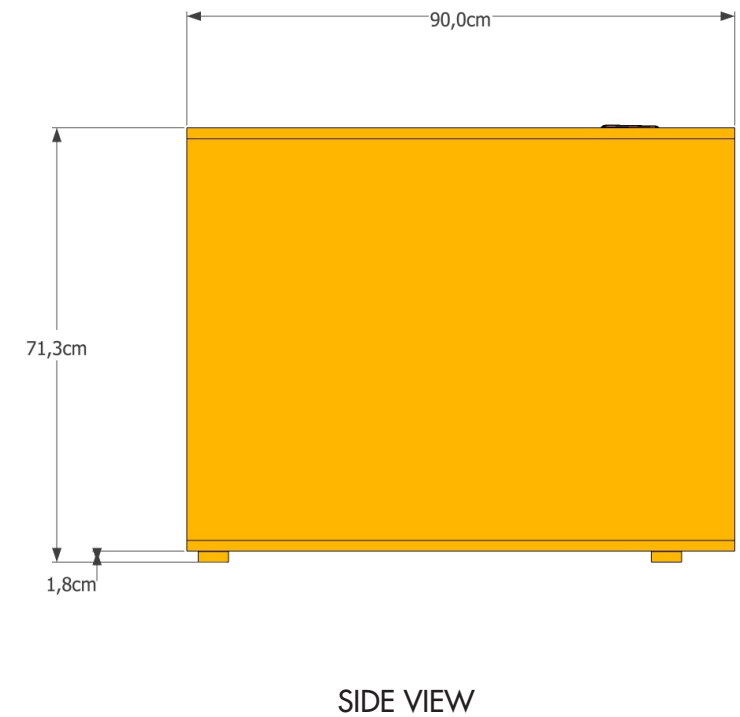
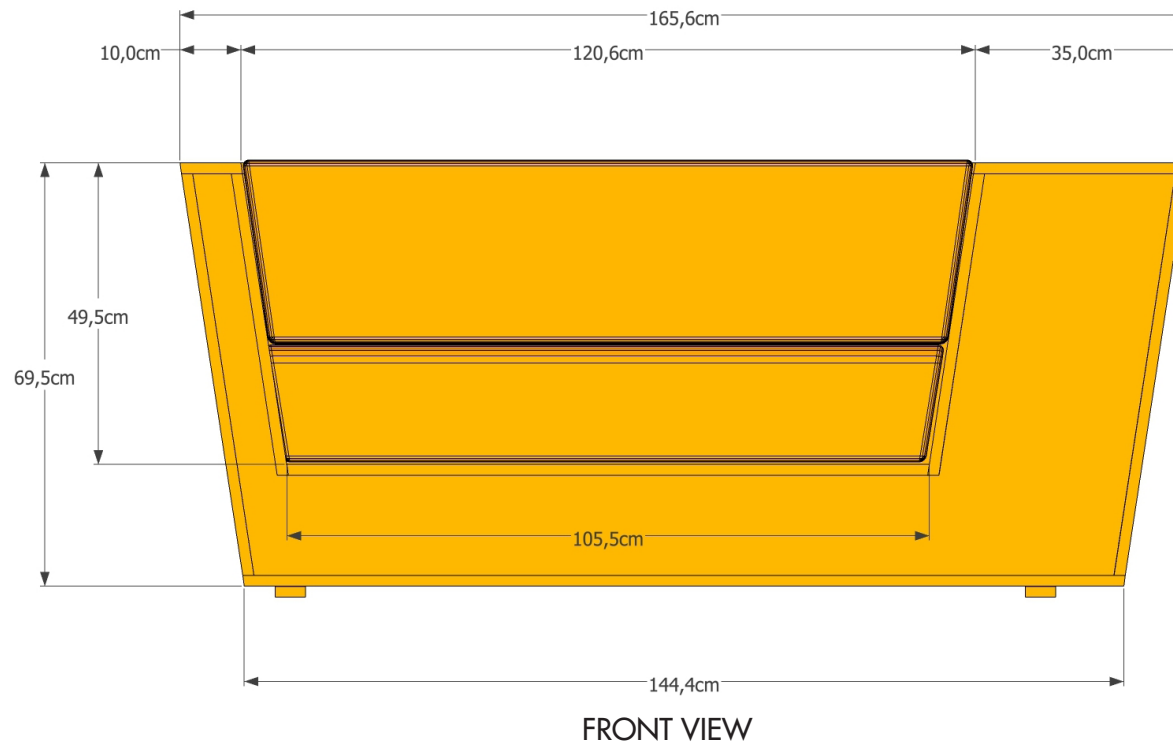

# C - Construction

---

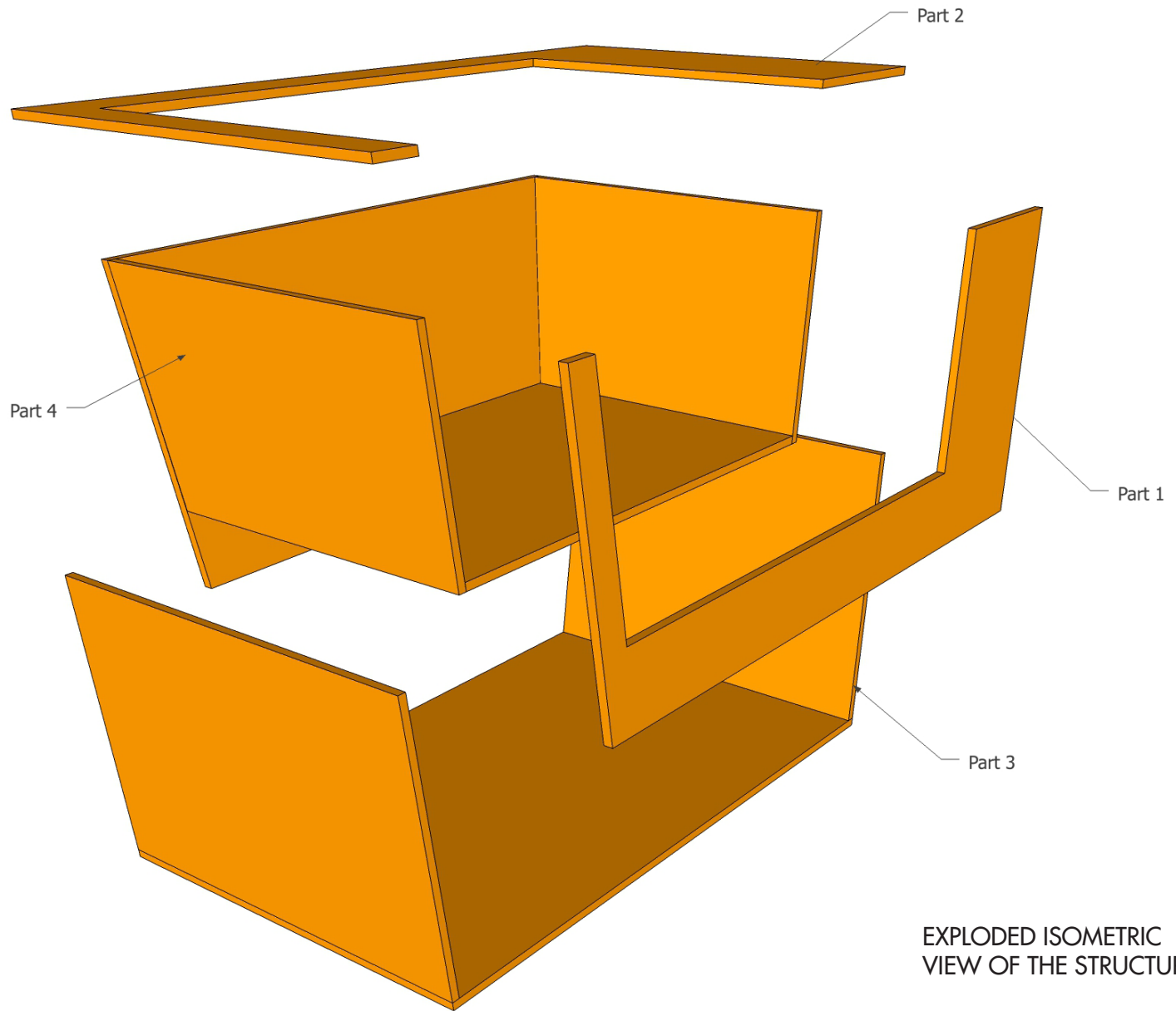
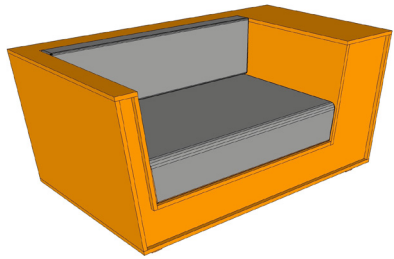

EXPLODED ISOMETRIC  
VIEW OF THE STRUCTURE



# D - Construction

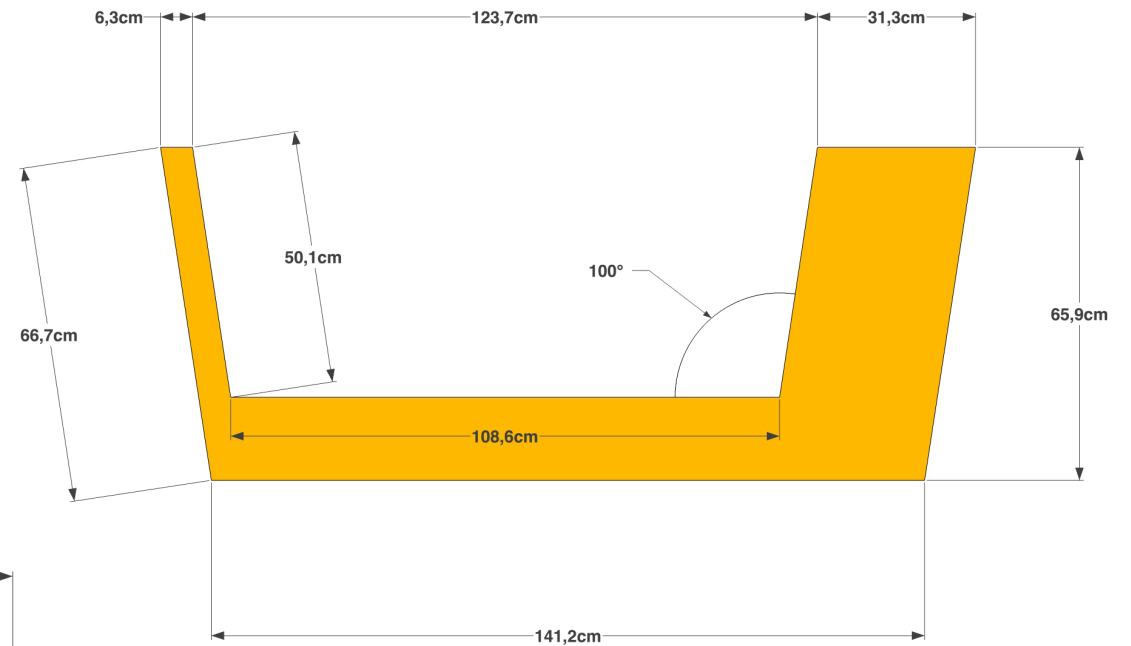
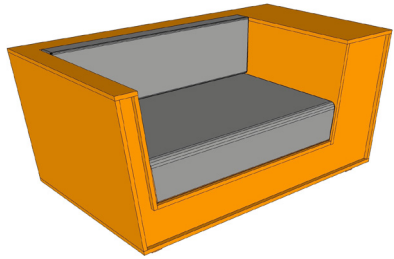

PART 1 DETAIL

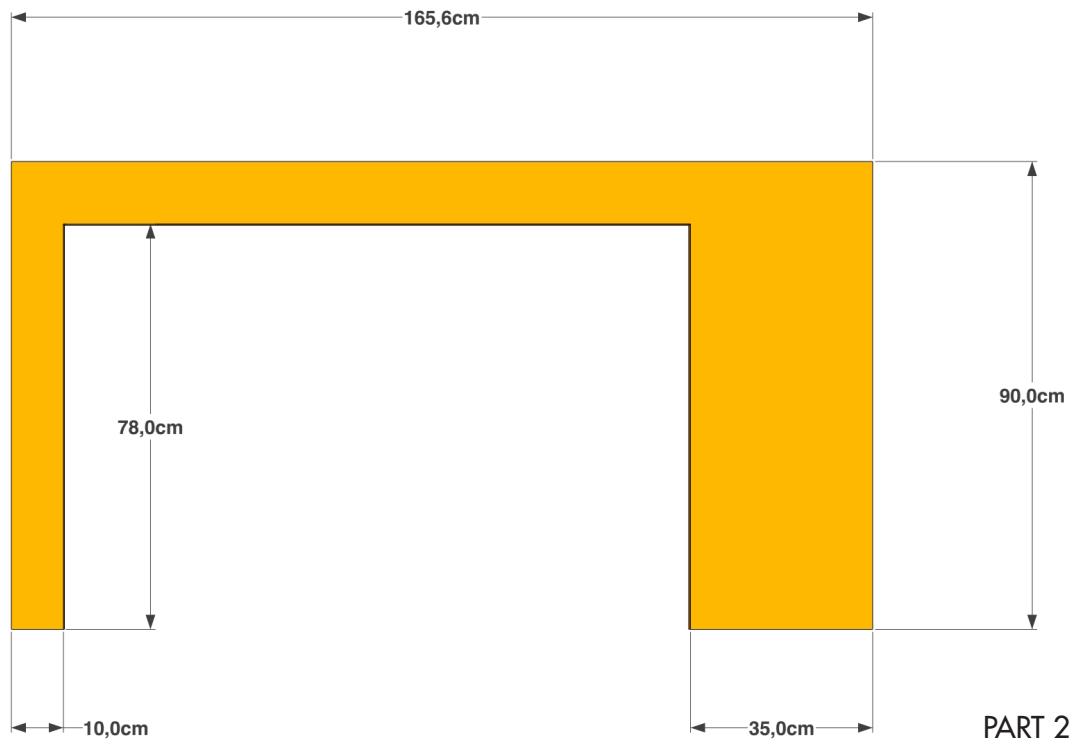

PART 2 DETAIL



# E - Construction

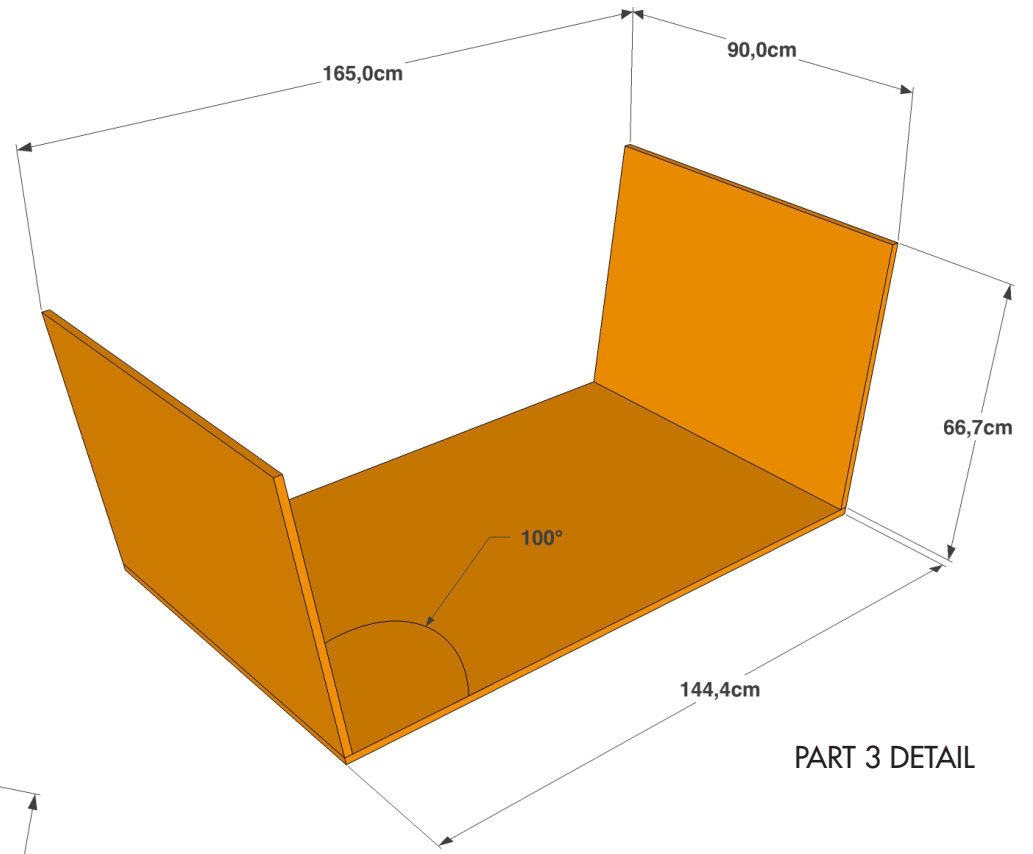
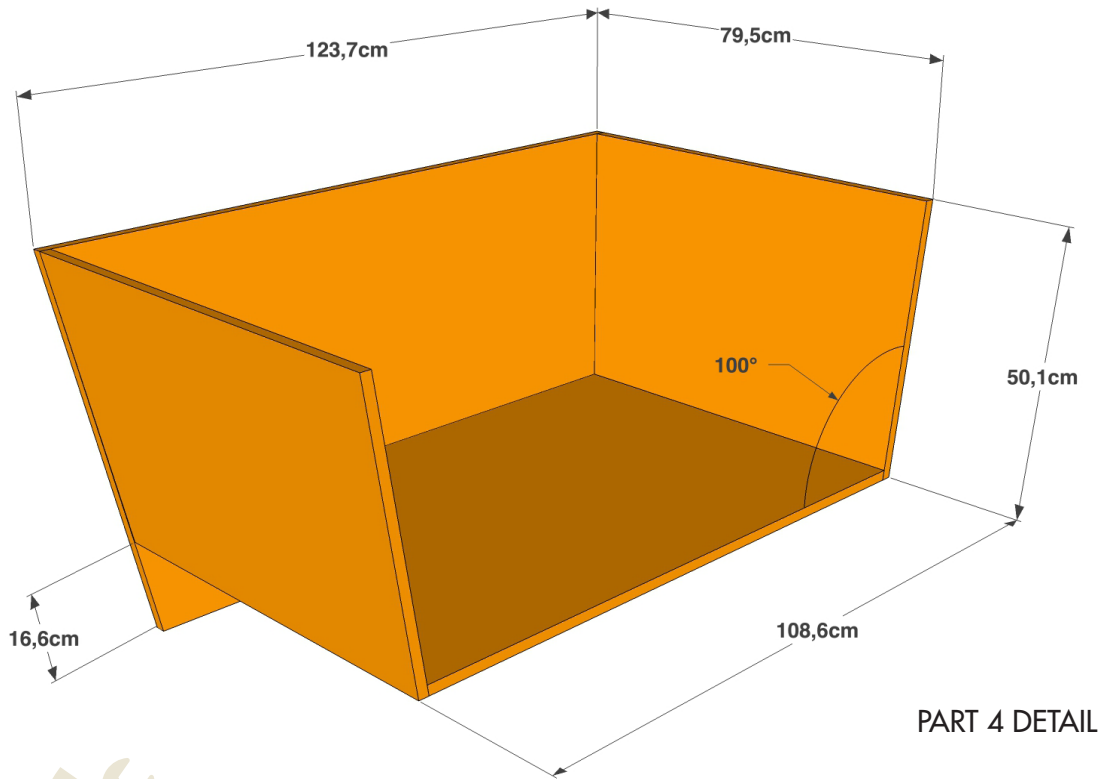
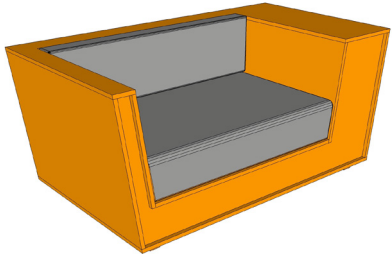

## E - Construction

---

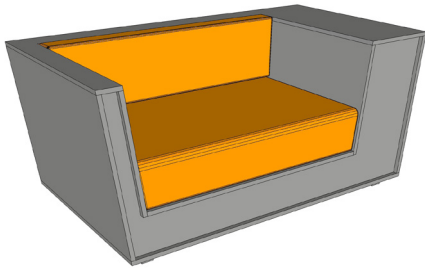

Measurements for the foam cushions should only be taken once the wooden structure is finalised to ensure a snug fit.

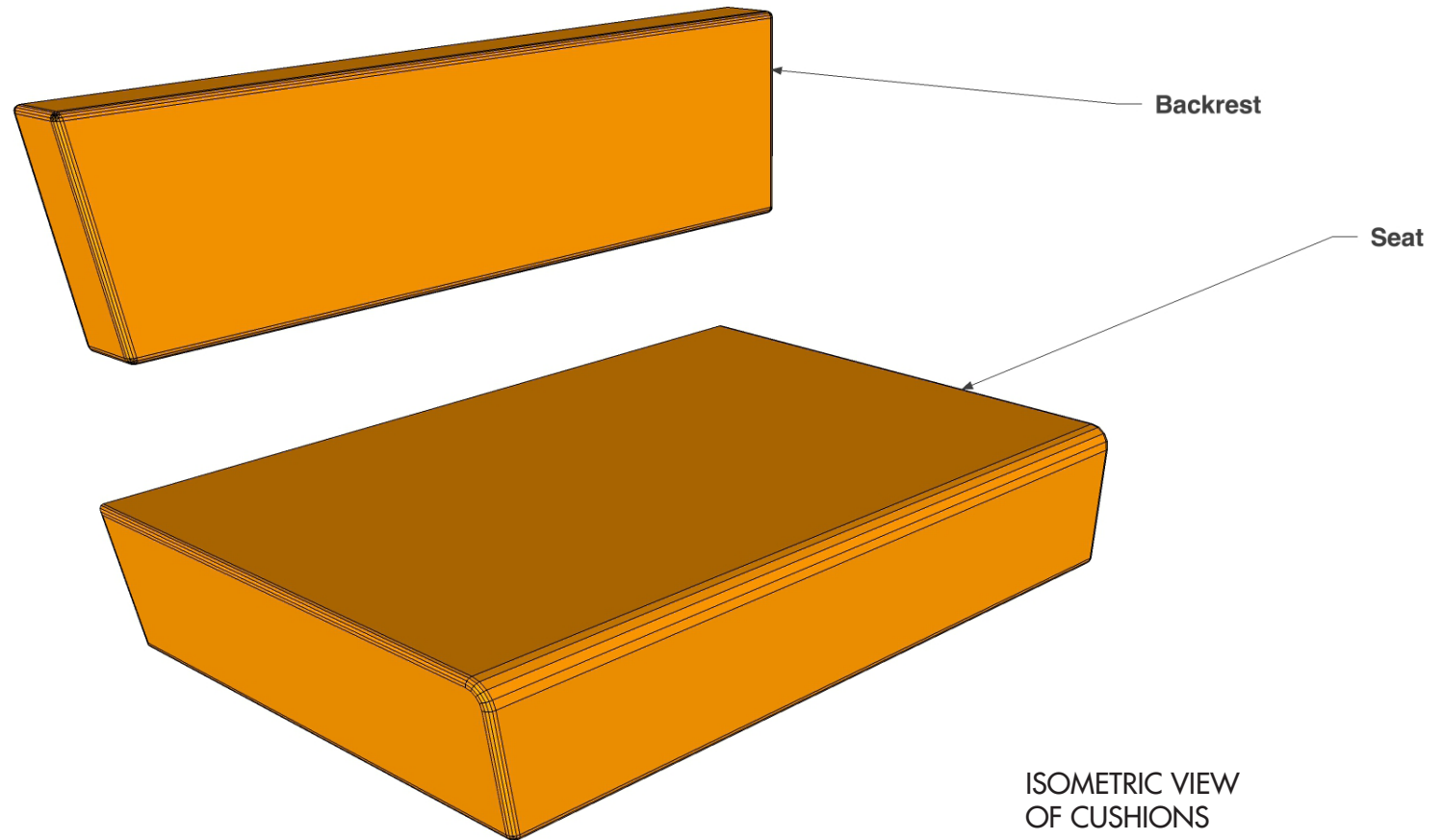

# Photo Gallery

---





## Help and assistance

---

If you have any questions regarding the design/production please get in touch with us on [sales@nothrowdesign.com](mailto:sales@nothrowdesign.com). Or if you happen to be in Barcelona come and pop by our **showroom**.

The registered owner of this design is Ryan Frank, however you are free to download the blueprints under the Creative Common License. Meaning you can copy and redistribute the blueprints in any medium or format and remix, transform, or build upon the products provided. What we would ask in return is to give us appropriate credit, provide a link to the license, and indicate if changes were made. If you remix, transform, or build upon our designs, you must distribute your contributions under the same license as the original. Our only restriction is to not use the design for commercial purposes. Find our full licensing terms here: <https://creativecommons.org/licenses/by-nc-sa/4.0/legalcode>



And should you have trouble finding a local Maker check out our Meet the Maker space [www.nothrowdesign.com/Meet-the-Maker](http://www.nothrowdesign.com/Meet-the-Maker). Here you can not only find links to a Makers database by country but also trusted individuals that we have worked with before.

Happy Making!

PS We would love to see a picture of the final product in your home (send to: [photos@nothrowdesign.com](mailto:photos@nothrowdesign.com))

